

Information & Communications Technology Network Infrastructure Group

Network Infrastructure Standards

Appendix E - Ordering

Version 1.6

Appendix E - Ordering

Please contact your suppliers for up-to-date information.

Note: It will be the responsibility of the data installer to supply all passive elements of the network infrastructure

Note: You cannot mix & match components from Excel and Leviton as this will void the warranty of each respective system.

Please contact NID for clarification ictns-infra-dl@imperial.ac.uk

Passive equipment – Copper

CAT5e U-UTP B2ca Cabling – Only to be installed in circumstances where a compliant CAT6a solution cannot be achieved. (please contact Imperial ICT for clarification)

Brand	
Excel	
Designation	Part code
<u>EXL C5E 4PR UTP VT X 305M B2CA</u>	190-066
Ethernet Category: Cat5E Outer sheath colour: Violet Overall screening: None Conductor screening: None Reaction-to-fire class according to EN 13501-6: B2ca Smoke development class according to EN 13501-6: s1a Flaming droplets/particles according to EN 13501-6: d1 Euro class acidity according to EN 13501-6: a1 Outside Diameter 5.1 mm Min Bend Radius (Installation) 8 x outside diameter Min Bend Radius (Operational) 4 x Outside diameter	
Packaging	
305m Fast feed box	

CAT5e Components

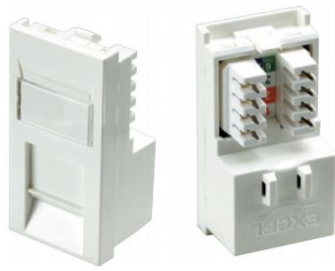
Brand	
Excel	
Designation	Part code
Excel Category 5e Office Unscreened Module - Low Profile - White	100-275
NB: Also available in grey to comply with Equality Act 2010 & Part M of building regulations where required.	
Packaging	
Single unit	
	

Brand	
Excel	
Designation	Part code
Excel Category 5e Unscreened Module Low Profile - 6C RJ45 - White	100-757
NB: For use in floor boxes	
Packaging	
Single unit	
	

Brand	
Excel	
Designation	Part code
Excel Office Single Gang Faceplate Complete with 2 Half Blanks - Office White	100-270
Excel Office Double Gang Faceplate Complete with 2 Half Blanks - Office White	100-271
NB: Also available in grey to comply with Equality Act 2010 & Part M of building regulations where required.	
Packaging	
Single unit	
	

Brand	
Excel	
Designation	Part code
Excel 24-port Angled Unloaded 1U (UTP/FTP) Keystone frame - Black	100-023
NB:	
Packaging	
Single unit	
	

Brand	
Excel	
Designation	
Excel Category 6 (UTP) Butterfly Style Toolless Angled Jack - Black	
Part code	
100-213	
<p>NB: CAT6 UTP angled modules to be used in lieu of CAT5e as no CAT5e angled module available at this present time. These are to be used with 24 port angled panel part no. 100-023</p>	
Packaging	
Single unit	
	

CAT6a U-FTP Cca Cabling – Our preferred cabling system, all new buildings & projects will be installed with this cabling type, unless otherwise stated by ICL ICT

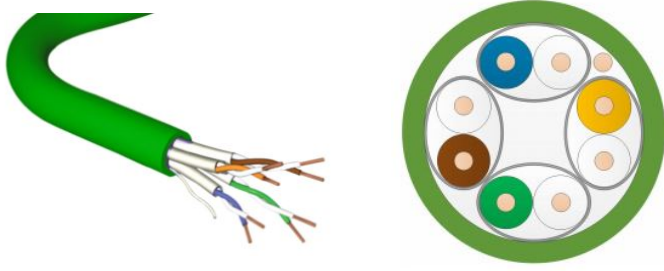
Brand	
Leviton	
Designation	Part code
Category 6A U/FTP EuroClass Cca Cable	AC6U/FTP-CCA-305GN
<p>Ethernet Category: Cat6a</p> <p>Outer sheath colour: Green</p> <p>Overall screening: None</p> <p>Conductor screening: Individually screened</p> <p>Reaction-to-fire class according to EN 13501-6: Cca S1a D1 a1</p> <p>Smoke development class according to EN 61034 Pass</p> <p>Flaming droplets/particles according to EN 60332-1-2 Pass</p> <p>Euro class acidity according to EN 60754 Pass</p> <p>Outside Diameter 6.7mm</p> <p>Min Bend Radius (Installation) 8 x outside diameter</p> <p>Min Bend Radius (Operational) 4 x Outside diameter</p>	
Packaging	
305m reel box or 500m cable reel	
	

Brand	
Leviton	
Designation	Part code
Category 7 S/FTP External cable	UM10-HF1-X
Note: To be used in all external locations where cabling will be not be in a protected environment. Please note external grade cabling can only be brought into the building 2m.	
<p>Ethernet Category: Cat7</p> <p>Outer sheath colour: Black</p> <p>Overall screening: Braided screened</p> <p>Conductor screening: Individually screened</p> <p>Reaction-to-fire class according to EN 13501-6: N/A External Only</p> <p>Smoke development class according to EN 61034 N/A</p> <p>Flaming droplets/particles according to EN 60332-1-2 N/A</p> <p>Euro class acidity according to EN 60754 N/A</p> <p>Outside Diameter 8.2mm</p> <p>Min Bend Radius (Installation) 8 x outside diameter</p> <p>Min Bend Radius (Operational) 4 x Outside diameter</p>	
Packaging	
500m reel	
	

Brand	
Leviton	
Designation	Part code
10GPlus Cat 6A Shielded Tool-Free Snap-In Jack	AC6JAKS000DC
Packaging	
Single unit	
	

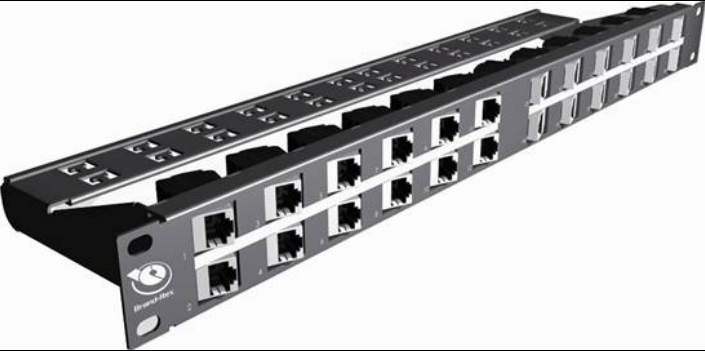
Brand	
Leviton	
Designation	Part code
24 Port 1U V12 Angled Snap-In-Jack Panel	MMCPNLX24SIJ2MAN
NB:	
Packaging	
Single unit	
	

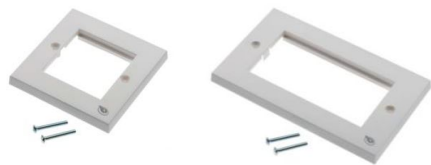
Brand	
Leviton	
Designation	Part code
1 gang 86 x 86mm Single Gang Faceplate, White	MMCWDOUNI030
2 gang 86 x 147mm Double Gang Faceplate, White	MMCWDOUNI031
Note: To comply with with Equality Act 2010 & Part M of building regulations contrasting inserts need to be installed when using Leviton faceplates.	
Packaging	
Single unit	
	

Brand	
Leviton	
Designation	Part code
Angled shutter 25 x 50 mm Angled Faceplate Module	MMCANG0623
NB:	
Packaging	
Single unit	
	

Brand	
Leviton	
Designation	Part code
6C 25 x 38 mm Shuttered Module – Floor Box / GOP Box Shutter	MMCWDO06C001
NB:	
Packaging	
Single unit	
	

Brand	
Leviton	
Designation	Part code
Cat 6A Universal Tool-Free RJ45 Connector.	6APLG-S6A
NB:	
Packaging	
Single unit	
	

Passive equipment – Fibre

Brand	
Leviton	
Designation	Part code
Optical Central Dry Tube B2CA Cable	GF-108-CDT24-LU-B2ca
<p>Outer sheath colour: Black</p> <p>Reaction-to-fire class according to EN 13501-6: B2ca S1a D1 a1</p> <p>Smoke development class according to EN 50399 Pass</p> <p>Flaming droplets/particles according to EN 50399 Pass</p> <p>Euro class acidity according to EN 50267 2-3 Pass</p> <p>Outside Diameter 7.0mm</p> <p>Tube Diameter 3.5m</p> <p>Min Bend Radius (Installation) 20 x outside diameter</p> <p>Min Bend Radius (Operational) 15 x Outside diameter</p>	
Note: To be used on internal applications.	
Packaging	
Reel cut to length / 2km /4km drum	
	

Brand	
Excel	
Designation	Part code
Enbeam OS2 Singlemode 9/125 24 Core Armoured CST Fibre Optic Cable Loose Tube B2ca - Blue	295-309
<p>Outer sheath colour: Blue</p> <p>Reaction-to-fire class according to EN 13501-6: B2ca S1a D0 a1</p> <p>Smoke development class according to EN 50399 Pass</p> <p>Flaming droplets/particles according to EN 50399 Pass</p> <p>Euro class acidity according to EN 50267 2-3 Pass</p> <p>Outside Diameter 9.5mm (+/- 0.5mm)</p> <p>Tube Diameter 3.2mm (+/- 0.3mm)</p> <p>Min Bend Radius (Installation) 20 x outside diameter</p> <p>Min Bend Radius (Operational) 10 x Outside diameter</p>	
Note: To be used on all external applications.	
Packaging	
Reel cut to length - drum	
	

Brand	
Corning	
Designation	Part code
FREEDM™ B2 Gel-free Loose Tube Dielectric Armour Indoor/Outdoor Cable	Dependant on core count
Outer sheath colour: Black	
Reaction-to-fire class according to EN 13501-6: B2ca S1a D1 a1	
Smoke development class according to EN 50399 Pass	
Flaming droplets/particles according to EN 50399 Pass	
Euro class acidity according to EN 50267 2-3 Pass	
Outside Diameter 13.9mm (Based on 96c fibre count)	
Tube Diameter 3.0mm (12c per tube)	
Min Bend Radius (Installation) 278mm based on 96c	
Min Bend Radius (Operational) 209mm based on 96c	
Note: To be used on all external applications.	
Packaging	
Reel cut to length - drum	

Brand	
Leviton	
Designation	Part code
LC Duplex Singlemode – 24-way (12 Duplex)	FPCC1SXSM24LC2
LC Duplex Singlemode – 48-way (24 Duplex)	FPCC1SXSM48LC2
Note: 24-way the preferred option, as allows us to split the diversly routed fibres over 2 cabinets when there are 2 cabinets installed	
Packaging	
Single unit	

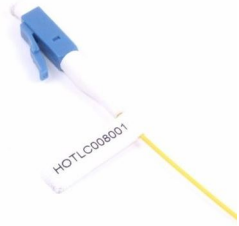
Brand	
Leviton	
Designation	Part code
LC SM 8/125 Pigtail	HOTLC008001
NB:	
Packaging	
Single unit	
	

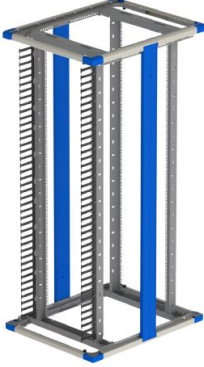

Cabinets



Brand	
EFS	
Note: 42U 800x1000 to be used in all situations unless it is to marry up with an existing cabinet that is 800d.	
Designation	
Part code	
<p>Access rack</p> 	<p>42U 800x875 - ACP0000237</p> <p>42U 800x1000 ACP0000340</p>
<p>Part Number:</p> <p>ACCESS with the following configuration: Rack Height 42/47 Unit Rack Width 800 Wide Rack Depth 875/1000 Deep Base Options Jacking Feet & Castors - (H) Rail Type 19" Rails (2 Pairs - RCM front - STD rear) - Front Rails STD - 128mm from front face (RCM Fingers will protrude front frame) - Rear Rails - 70mm from rear face Front Door No Door Rear Door No Door Side Panels No Side Panels Top Panel Front Option No Panel Top Panel Middle Option No Panel Top Panel Rear Option No Panel</p> <p>40 x TLCMS and 40 X TLCMEF fitted front only - evenly distributed RCM Fingers fitted front only Supply with BTK loose 1 x Earth Kit 2 x ABS4230 Fitted each side, fitted to offset rear (front edge in line with centre extrusions) 2 Pair Unit Height Labels (Bottom to Top) - Fit front/Rear</p> <p>Rack Colour Grey with Blue Trim</p>	

Brand	
Excel	
Designation	Part code
Excel Switched - 12 Way 45° Angle UK Socket PDU - Master Switch - 16A IEC 60309 Plug - Vertical	D16-12-EXL
NB:	
Packaging	
Single unit	
	

Brand	
Hellermann Tyton /CMS	
Designation	Part code
5 Ring (Plastic) Cable Management bar	CTB05PRB
NB:	
Packaging	
Single unit	
	

<p>Accessories</p>	
<p>Spliced Fibre</p> <p>Centrix™ Unit, 4U, 12 Cassettes each with 24 LC UPC adapters & SM pigtails, 250 µm standard SM pigtails, total of 288 F</p>  <p>http://catalog.corning.com/opcomm/en-GB/catalog/ProductDetails.aspx?cid=centrix_hardware_web&pid=122941&vid=122946&rot=</p>	<p>CX4U8P24-A9-2RH000</p>
<p>Fibre lead</p> <p>EDGE™ Solutions Low-loss Patchcord, LC duplex uniboot connectors, SMF-28® Ultra OS2, standard reverse fibre polarity, LSZH/FRNC jacket, yellow, 4 m</p> <p>Note: for inter-ODF cabinet connection get the 7m patch lead, for single ODF cabinet connection get the 4m patch lead and for the distribution and router cabinet(s). The number highlighted in red denotes length</p>  <p>http://csmedia.corning.com/opcomm/Resource_Documents/spec_sheets_rl/fo_cab/E787802GNZ20004M_CALA_AEN.pdf</p>	<p>E787802GNZ20004M</p>

<p>MTP to LC Presentation</p> <p>Centrix™ standard access 4RU mounted HSG empty Centrix™ Mod 24 LC/UPC-2MTP PRT FRNT RGT (each has 2 MTP connectors and 12 duplex LC)</p>  <p>http://catalog.corning.com/opcomm/en-GB/catalog/ProductDetails.aspx?pid=122915&vid=122916&cid=&productid=122915</p> <p>http://catalog.corning.com/opcomm/en-GB/catalog/ProductDetails.aspx?pid=143255&vid=143259&cid=&productid=143255</p>	<p>CTX-S4U</p> <p>CTX24A9-892RRR</p>
<p>MTP Presentation</p> <p>EDGE™ Housing, 1 rack unit, holds up to 12 EDGE modules or panels</p>  <p>http://catalog.corning.com/opcomm/en-GB/catalog/ProductDetails.aspx?cid=edge_housings_web&pid=130469&vid=130486&rot=</p>	<p>EDGE-01U-SP,</p>

<p>MTP Harness</p> <p>EDGE™ Solutions Harness, SMF-28® Ultra OS2, 12 fibres, MTP® to 6 LC Duplex Uniboot Connectors, Universal LC 150mm stagger, 1.65 m</p> <p>Note: Check stagger and length prior to purchasing.</p> 	<p>H897812GLZ-4A1.65M</p>
<p>CTX Module</p> <p>Centrix™ 24 Port LC/UPC MTP® module.</p> <p>Note: The letter highlighted in red denotes left or right handed.</p> 	<p>CTX24A9-892RU</p> <p>CTX24A9-892RLU</p>
<p>Accessories</p>	

<p>Fibre Optic Cleaning Tool used to clean MTP® connector end faces as well as MTP Connectors installed in a module</p>  <p>http://catalog.corning.com/opcomm/en-GB/catalog/ProductDetails.aspx?cid=edge_accessories_web&pid=29909&vid=110987&rot=</p>	<p>2104466-01</p>
<p>NOTE: Please bear in mind that some of the products have no part code as they depend on length and number of fibre cores and hence need to be ordered to fit the design. Unfortunately, we cannot provide a “one size fits all” information in this document for these products. Please contact ICT if necessary.</p>	

Fire stopping (Cable Transit Pathways)

<p>Brand</p>	
<p>Legrand Cablofil</p>	
<p>Designation</p>	<p>Part code</p>
<p>EZ-Path Fire Transit Pathways</p>	
	<p>EZD44 EZ Path Max - CM250058</p>
<p>Note: You will need to order wall / floor plates to suit the application.</p>	
<p>Ordering</p>	
<p>sales@cabcon.co.uk</p>	



Patch cords



Brand	
Assynia	
Designation	
Part code	
CAT5e	
Booted CAT5e patch cable (0.5m) – all colours	FB5E-005
Booted CAT5e patch cable (1.0m) – all colours	FB5E-010
Booted CAT5e patch cable (1.5m) – all colours	FB5E-015
Booted CAT5e patch cable (2.0m) – all colours	FB5E-020
Booted CAT5e patch cable (3.0m) – all colours	FB5E-030
Booted CAT5e patch cable (4.0m) – grey only	FB5E-040GY
Booted CAT5e patch cable (5.0m) – all colours	FB5E-050
Booted CAT5e patch cable (6.0m) – grey only	FB5E-060GY
Booted CAT5e patch cable (7.0m) – all colours	FB5E-070
Booted CAT5e patch cable (10.0m) – all colours	FB5E-0100
Booted CAT5e patch cable (15.0m) – grey only	FB5E-0150GY
Ordering	
CMS (http://www.cmsplc.com/)	
	



Brand	
Excel	
Designation	
Part code	
CAT6A	
Booted CAT6a patch cable (1.0m) – blue	100-159
Booted CAT6a patch cable (1.5m) – blue	101-141
Booted CAT6a patch cable (2.0m) – blue	100-157
Booted CAT6a patch cable (3.0m) – blue	100-158
Booted CAT6a patch cable (1.0m) – red	100-161
Booted CAT6a patch cable (1.5m) – red	101-142
Booted CAT6a patch cable (2.0m) – red	100-162
Booted CAT6a patch cable (3.0m) – red	100-163

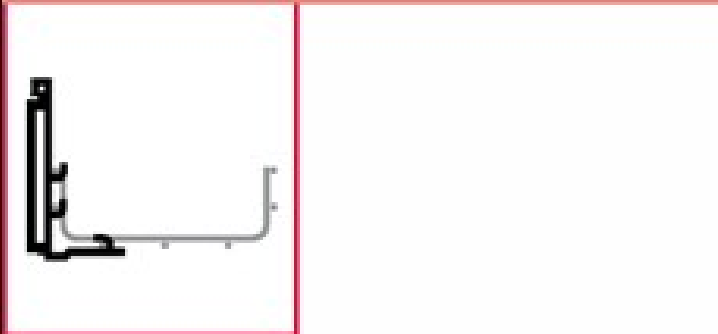

Ordering	
paul.collins@mayflex.com	

Containment

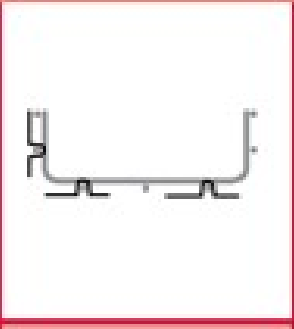
Brand	
Cablofil or Equivalent	
Designation	Part code
Cablofil steel wire cable tray or	
There are too many options available. These will need to address specific job/project requirements.	
Ordering	
 	
https://www.legrand.co.uk/products/cable-management/cablofil/	
http://www.cablofil.co.uk/sites/default/files/Cablofil_low_res_0.pdf	
https://www.legrand.co.uk/media/4564/cablofil_steel_wire_cable_tray.pdf	(all product guide – Use part code search to find product)
Accessories:	
DEV100GS Cable Dropout Plate	CM585160

<p>CLIPN Black Identification Tag Pack: 1 pk of 50 *</p>  <p>* Please note that there are packs with more quantities</p>	<p>CM559127</p>
<p>Cable Exit</p> 	<p>CM350535</p>
<p>Conduit Clamp Kit (Bottom and side installation)</p> 	<p>CM585410</p>

		
<p>RADT90 Radius Shield</p> 		<p>CM840101 CM840111 CM840131</p> <p>CM840103 CM840113 CM840133</p>
<p>GRIFE QUIP</p> 		<p>CM585327</p>
<p>Elevation Change Hinge</p>		<p>Parts Required: 2x CM558403 8x CM801011 4x CM558011</p>

<p>Divider Strip</p> 	<p>COT</p> <p>CM923010 CM923020 CM923030 CM923040</p> <p>CM923013 CM923023 CM923033 CM923043</p> <p>CM923014 CM923024 CM923044</p>
<p>Divider Coupler</p> 	<p>COT J</p> <p>CM923050 CM923054</p>
<p>Tray Reduction Kit</p>	<p>EDRSKIT</p> <p>Parts required 1 x CM558211</p>

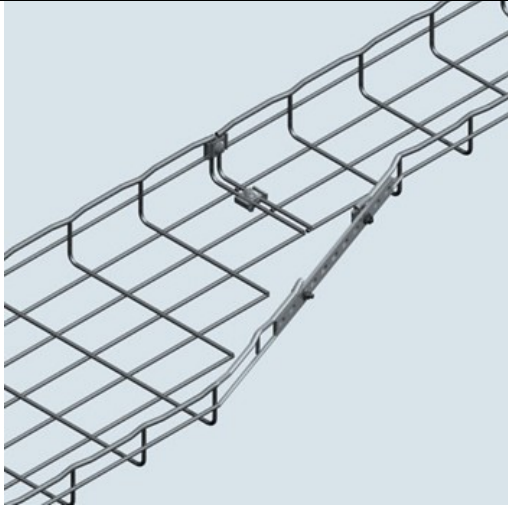
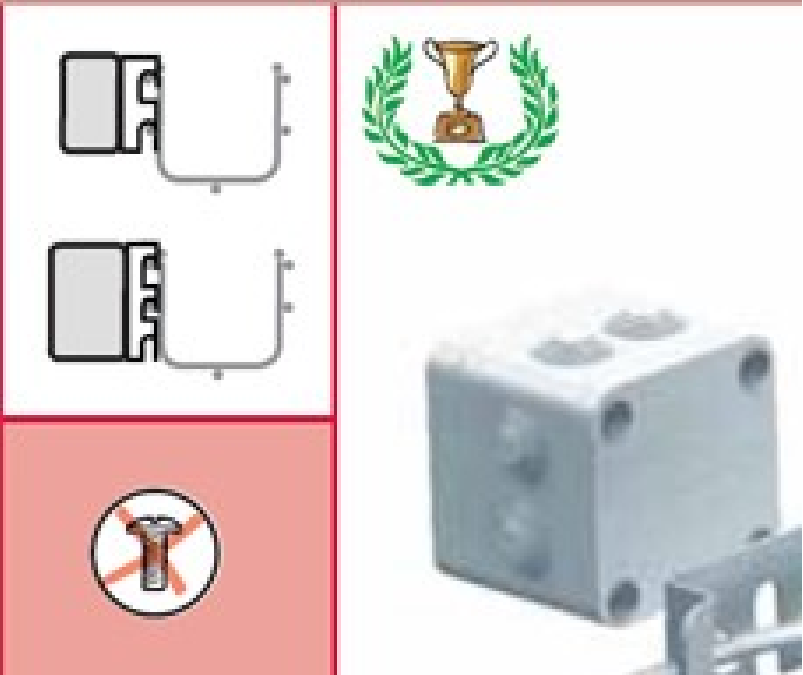
 <p>https://www.legrand.us/cablofil/cable-tray-wire-mesh/splicing/edrskit.aspx</p> <p>https://www.legrand.us/-/media/brands/cablofil/cablofil-products/cable-tray-wire-mesh/cutsheets/edrskit%20cutsheet.ashx</p>	<p>4 x CM801011 4 x CM558011 2 x CM558041</p>
<p>Conduit and box support</p>  <p>http://www.cablofil.co.uk/product/box-conduit/cm50-cm50-xl-cat40</p>	<p>CM50 / CM50 XL / CAT40</p>
<p>Angle Bracket</p>	<p>Parts required:</p> <p>1 x CM557300 2 x CM801011 2 x CM558011</p>

	2 x CM558041
US Products available to ICL installers (or replacement):	
<p>DO Waterfall Dropout</p> <p>(https://www.legrand.us/cablofil/cable-tray-wire-mesh/other-mounting/do/)</p> <p>https://www.legrand.us/-/media/brands/cablofil/cablofil-products/cable-tray-wire-mesh/cutsheets/do%20cutsheet.ashx</p>	DO54/150 DO54/300 DO105/150 DO105/300
<p>Over-the-top dropout</p> <p>https://www.legrand.us/cablofil/cable-tray-wire-mesh/other-mounting/otdofas.aspx</p> <p>https://www.legrand.us/-/media/brands/cablofil/resources/cut-sheet/cabcs0706%20-%20mini%20waterfall.ashx</p>	OTDOFAS
<p>Universal Drop Out</p> <p>https://www.legrand.us/cablofil/cable-tray-wire-mesh/other-mounting/udo.aspx</p> <p>https://www.legrand.us/-/media/brands/cablofil/resources/cut-sheet/cf-cutsheet-universal-drop-out.ashx</p>	UDO
<p>Cable Bundler (Optional to Velcro)</p> <p>https://www.legrand.us/cablofil/cable-tray-wire-mesh/other-mounting/cablo-snap.aspx</p> <p>https://www.legrand.us/-/media/brands/cablofil/cablofil-products/cable-tray-wire-mesh/cable-management-accessories/cable-bundler/cablosnap/cabcs1018-cablo-snappdf.ashx</p>	CABLO SNAP

Brand	
Erico or Equivalent	
Designation	Part code
J-Hooks	
Ordering	
CMS (http://www.cmsplc.com/)	
	
CADDY CAT HP - (J-Hooks) 100mm	HPJ100

Brand	
Viking or Equivalent	
Designation	Part code
A4 Document wallet	W230
Ordering	
https://www.viking-direct.co.uk/en/p/W230	
	

Brand	
Veracity –	
Note: To be used where extended distances are required externally for CCTV. Maximum distance 200m. Contact NID Team for further information.	
Designation	Part code
Outreach MaxXT	VOR-ORM-XT
Ordering	

Active equipment

WAPs

Brand	
Cisco	
Designation	Part code
Imperial College ICT will specify the units and design the implementation.	
Further information to be found in appendix J	
Ordering	
Imperial College London - ICT	

Switches

Brand	
Juniper	
Designation	Part code
Imperial College ICT will specify the units.	
Ordering	
Imperial College London - ICT	